

# ALKON®

## OFFICE PRODUCTS

AUTHORISED DISTRIBUTOR

**SHREERAM METAFUSION ENG'S PVT. LTD.,**

SHOP-1, GAGANGIRI, SECTOR 17, VASHI, NAVI MUMBAI 400703.

TEL.: 2789 1522 / 2789 1549 FAX: 6791 0552

email: [metafusion@vsnl.net](mailto:metafusion@vsnl.net)

website : [www.shreeram-metafusion.com](http://www.shreeram-metafusion.com)



CAT.- 2009

# ALKON MODULAR SYSTEMS - BEIGE / GREY / BLUE

## Modular System - Beige / Grey / Blue

is an ideal plastic filing system based on standard modules which can be interlocked and stacked on top of each other.



The basic system is around four drawer sizes which can be interchanged in the ratio of 1 : 2 : 3 : 4. all cabinets can be supplied with / without central locking system.

### Applications

Due to the system being modular in nature, these systems are used in a large variety of applications like Offices, Hospitals, Homes, Electronics, Engineering and Textile Industries.



## MODULAR SYSTEMS -BEIGE



CABINET & DRAWERS      DRAWER FRONT  
**COLOUR**            

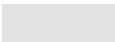

## MODULAR SYSTEMS- GREY



CABINET & DRAWERS      DRAWER FRONT  
**COLOUR**            

## MODULAR SYSTEMS-BLUE



CABINET & DRAWERS      DRAWER FRONT  
**COLOUR**            

AUTHORISED DISTRIBUTOR

**SHREERAM METAFUSION ENG'S PVT. LTD.,**

SHOP-1, GAGANGIRI, SECTOR 17, VASHI, NAVI MUMBAI 400703.  
 TEL.: 2789 1522 / 2789 1549 FAX: 6791 0552

email: [metafusion@vsnl.net](mailto:metafusion@vsnl.net) website : [www.shreeram-metafusion.com](http://www.shreeram-metafusion.com)

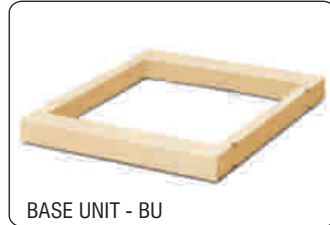
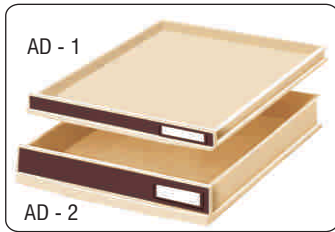

**SPECIAL STOPPERS**

Special stopper is provided to stop the drawers when opened fully. To remove drawer from the cabinet lift the drawer up & remove from cabinet.

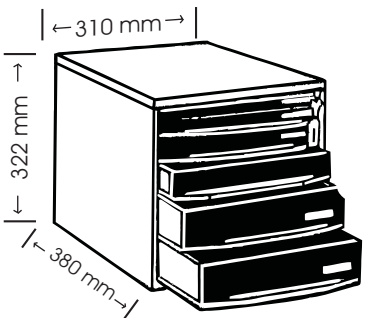

**INTERNAL SIZE OF DRAWERS**

- AD 1 360 mm 265 mm x 16 mm
- AD 2 360 mm x 265 mm x 39 mm
- AD 3 360 mm x 265 mm x 62 mm
- AD 4 360 mm x 265 mm x 87 mm
- AMS 12-Modular system with 12 AD 1 Drawers
- AMS 6 - Modular system with 6 AD 2 Drawers
- AMS 4 - Modular System with 4 AD 3 Drawers
- AMS 3 - Modular System with 3 AD 4 Drawers

**MIXED DRAWER SYSTEM**

Modular System can be fitted with different size of drawers in the same cabinet. For example, One AD-4 drawers, can be replaced by two AD -2 drawers, or one AD -3 drawer and one AD-1 drawer.

**INDICATOR**

Name plate can be changed by pushing out the paper from the indicator as shown.

**BASE UNIT**

Base unit can be used with castors to make a mobile unit. One or more base units can be used (Joined by set of four dowels provided ) under the Modular system to raise the cabinet from the floor. Height of base unit is 35mm.

**CENTRAL LOCKING SYSTEM**

Is provided OPTIONALLY. Product numbers for cabinet with locks will be AMS 12L, AMS 6L, AMS 4L ect.



Mobile Unit Assembly



Combination of Containers

**UTILITY CONTAINERS**

For storing of small parts, Three sizes of containers are available to fit in AD3 drawers.

**Utility Containers available in 3 Sizes ( in Beige & Grey Colours)**

- UC 1 size 82 x 82 x 55
- UC 2 size 170 x 82 x 55
- UC 3 size 255 x 82 x 55

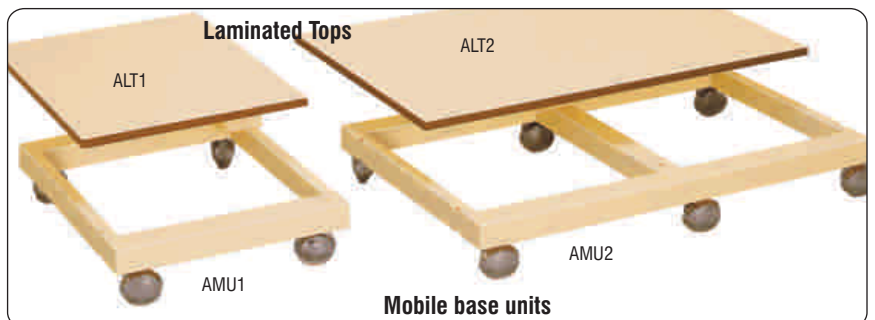

**Laminated Tops**

ALT1

ALT2

AMU1

AMU2

Mobile base units

AUTHORISED DISTRIBUTOR

**SHREERAM METAFUSION ENG'S PVT. LTD.,**

SHOP-1, GAGANGIRI, SECTOR 17, VASHI, NAVI MUMBAI 400703.  
TEL.: 2789 1522 / 2789 1549 FAX: 6791 0552

email: metafusion@vsnl.net website : www.shreeram-metafusion.com